

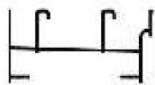









Aluminio
Pergamino

Perfiles

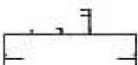
Código	Forma	Denominación	Peso Kg/m
LH-001		Marco Corrediza Pesado	0,550
LH-002		Cabezal / Zócalo de Hoja	0,400
LH-003		Parante Lateral Grande	0,400
LH-004		Parante Central Grande	0,420
LH-005		Mosquitero	0,320
LH-006		Mosquitero Medianito	0,230
LH-007		Marco Paño Fijo	0,580
LH-008		Contravidrio Recto	0,160
LH-009		Canal 9 - Mosquitero Liviano	0,190
LH- SIN MATRIZ		Contravidrio para Masilla	0,190
LH-011		Guía de Cortina Común	0,290

Peso +/- 5% / La Empresa se reserva el derecho de modificaciones sin previo aviso.

Perfiles



Aluminio
Pergamino

Código	Forma	Denominación	Peso Kg/m
LH-012		Guía de Cortina Común	0,330
LH-013	SIN MATRIZ		
LH-014		Tapacintas Liviano	0,240
LH-015		Tapacintas Pesado	0,480
LH-016		Escuadra Universal 13mm	0,750
LH-017		Umbral Bajo (Balconero)	1,050
LH-018		Perimetral VRP Rayado	0,195
LH-019		Nudo VRC Rayado (c/cava)	0,285
LH-020		Nudo VRC Rayado (s/cava)	0,250
LH-021		Guía Cortina Barrio	0,600
LH-022		Perimetral VRP Liso Chico	0,175
LH-023		Nudo VRC Liso Chico (c/ cava)	0,260

Peso +/- 5% / La Empresa se reserva el derecho de modificaciones sin previo aviso.

(2)

Código	Forma	Denominación	Peso Kg/m
LH-024		Nudo VRC Liso Chico (s/cava)	0,245
LH-025		Perimetral VRP Liso Gde	0,215
LH-026		Nudo VRC Liso Gde (c/cava)	0,330
LH-027		Escuadra 2001 Liviana	0,350
LH-028		Parante Chico Hoja Postigón	0,480
LH-029		Parante Grande Hoja Postigón	0,590
LH-030		Marco Chico Postigón	0,340
LH-031		Marco 75mm Postigón	0,560
LH-032		Tablilla Postigón Recta	0,260
LH-033		Tablilla Veneciana	0,160
LH-034		U de Armado 75 x 25 (Pte ABA)	0,490

Perfiles



Aluminio
Pergamino

Código	Forma	Denominación	Peso Kg/m
LH-035		Escuadra Estriada	1,200
LH-036		Tubo Liso 75x25	0,870
LH-037		Tubo Liso 90x40	1,340
LH-038		Tubo Liso 92 x 42 x 3 mm	2,081
LH-041		Parante de Hoja de Puerta	0,950
LH-042		Cabezal/Trav. /Zócalo Puerta	0,950
LH-043		Marco Puerta 36 mm	0,580
LH-044		Zócalo Alto Puerta Corrediza	0,670
LH-045		Marco Postizo Corrediza	0,420
LH-046		Revest.Liviano (t/Acan. 5 mm)	0,490
LH-047		Revest. Liviano (t/Acan. 9 mm)	0,550

Peso +/- 5% / La Empresa se reserva el derecho de modificaciones sin previo aviso.

(4)

Perfiles

Código	Forma	Denominación	Peso Kg/m
LH-048		Revestimiento Tubular	0,920
LH-049		Travesaño Tabique	0,560
LH-050		Tapa Columna Tabique	0,600
LH-051		Columna Tabique	0,710
LH-052		Marco Puerta Placa	0,400
LH-053		Marco Aireador c/Aleta y Mosq.	0,450
LH-054		Premarco	0,560
LH-055		Unionero	0,530
LH-056		Marco de 4 Guías	1,100
LH-057		Marco Doble Guía con Postigón	1,050
LH-058		Marco de Puerta Placa 75 mm	0,490







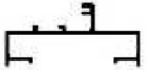
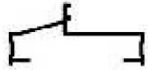
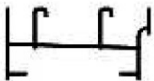

Peso +/- 5% / La Empresa se reserva el derecho de modificaciones sin previo aviso.

Perfiles

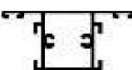
Código	Forma	Denominación	Peso Kg/m
LH-059	 SIN MATRIZ	Marco de Puerta Placa 100 mm	0,510
LH-060		Tablilla	0,275
LH-061	 SIN MATRIZ	Parante de puerta c/v repartido	0,805
LH-062	 SIN MATRIZ	Parante Gde. Postigón c/V. Rep.	0,640
LH-064		Parante Chico Postigón c/V Rep.	0,465
LH-065	 SIN MATRIZ	Marco de Corrediza BBII	0,530
LH-066		Unionero pata larga liviano	0,375
LH-067	 SIN MATRIZ	Marco corrediza c/contramarco	0,740
LH-068	 SIN MATRIZ	Bisagra Banderola	0,275
LH-069	 SIN MATRIZ	Marco Ventana Banderola	0,735
LH-070	 SIN MATRIZ	Marco Chico Ventana Banderola	0,525

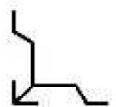
Código	Forma	Denominación	Peso Kg/m
LH-071	 SIN MATRIZ	Hoja Inferior	0,495
LH-072	 SIN MATRIZ	Hoja Superior	0,495
LH-073		Encuentro Hoja	0,230
LH-074	 SIN MATRIZ	Marco paño fijo 32mm	0,370
LH-075	 SIN MATRIZ	Marco de Pta. de Rebatir Pesado	0,713
LH-076	 SIN MATRIZ	Cabezal/ Zócalo Liviano	0,670
LH-090		Travesaño Hoja Mosquitero	0,460
LH-094		Travesaño Paño Fijo	1,180
LH-102		Cabezal/ Zócalo Liviano	0,360
LH-103		Parante Lateral Chico	0,365
LH-104		Parante Central Chico	0,350

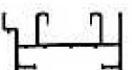
Perfiles

Código	Forma	Denominación	Peso Kg/m
LH-107		Marco Paño Fijo Liviano	0,450
LH-109		Marco Puerta 41mm de placa	0,465
LH-121		Marco de Corrediza Liviano	0,530
LH-153		Parante Lateral Reforzado	0,621
LH-154		Parante Central Reforzado	0,570
LH-155		Travesaño	0,640
LH-156		Contravidrio universal	0,205
LH-159		Escuadra reforzada	0,480
LH-307		Tablilla cortina de enrollar	0,420
LH-901		Marco corredizo Ekonal 901	0,750
LH-945		Encuentro de hoja 36 mm	0,297

VENTANA CORREDIZA

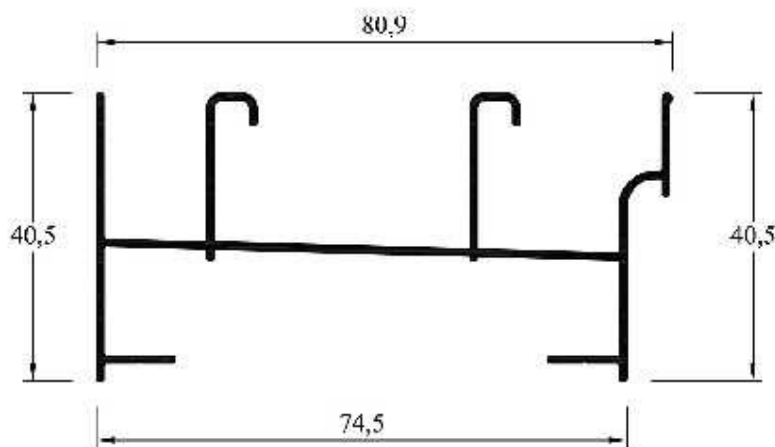

LH-001
Marco Corrediza Pesado
Peso: 0,630 kg/ml *
Paquete x 6 tiras
Peso aprox. paq.: 23 kg

LH-121
Marco Corrediza Liviano
Peso: 0,530kg/ml *
Paquete x 6 tiras
Peso aprox. paq.: 19,2 kg

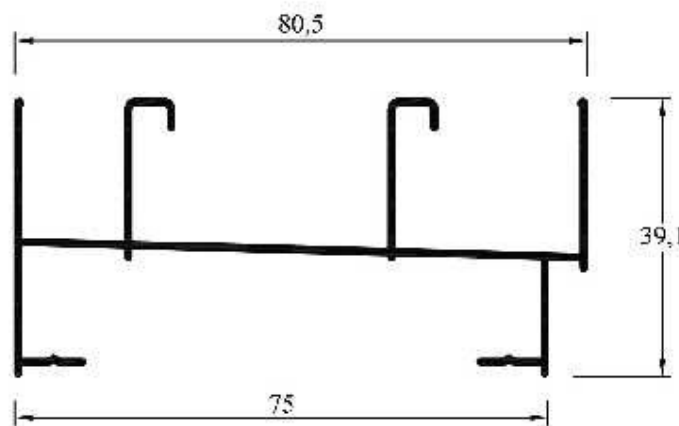

LH-065 (MPB 4101)
Marco Corrediza BBII
Peso: 0,530 kg/ml
Paquete x 4 tiras
Peso aprox. paq.: 12,8 kg

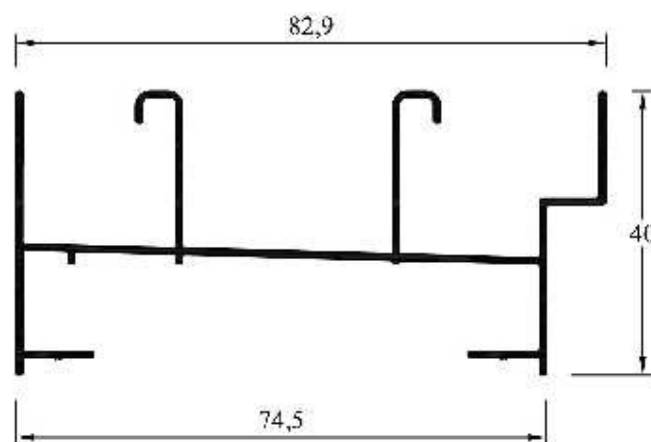

LH-3991
Marco Corrediza Liviano
Peso: 0,580 kg/ml
Paquete x 4 tiras
Peso aprox. paq.: 14,1 kg

* Consultar por pesos entre 0,530 y 0,630

VENTANA CORREDIZA

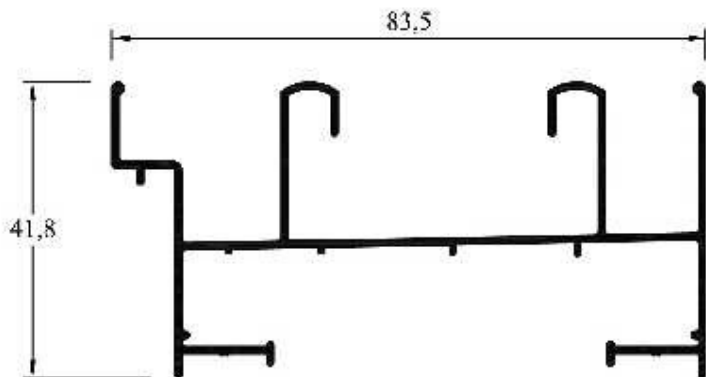

LH-901 (MBP- 3392)
Marco Corrediza
Peso: 0,750 kg/ml
Paquete x 6 tiras
Peso aprox paq. : 27,1 kg

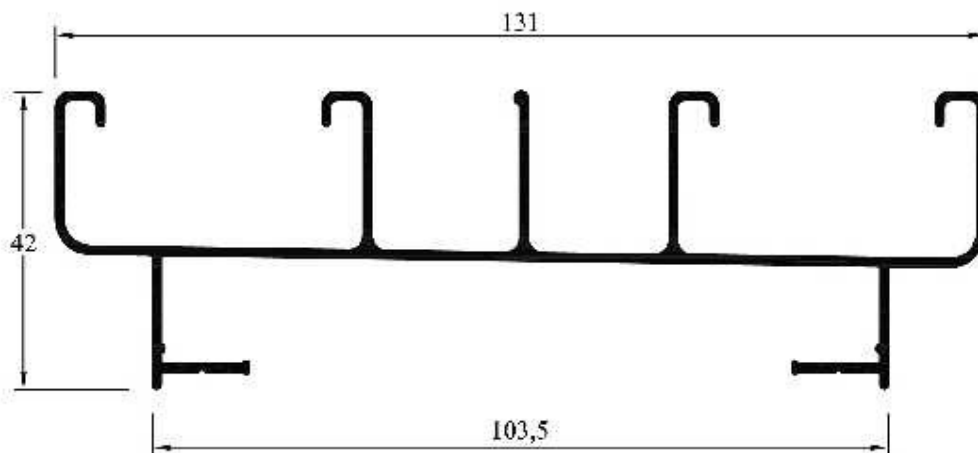

LH-056(MPB 4043)
Marco Doble Guía
Peso: 1,100 kg/ml
Paquete x 4 tiras
Peso aprox. paq.:26,5 kg

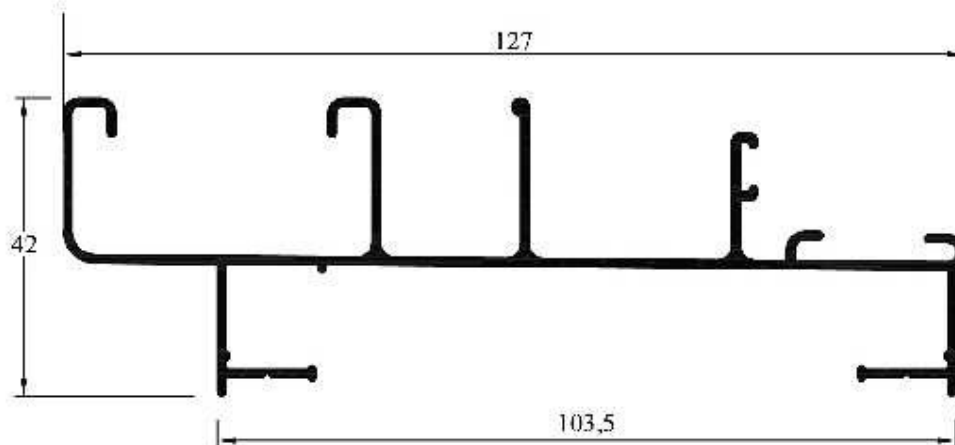

LH-057(MPB 4044)
Marco Guía con Postigón
Peso: 1,050 kg/ml
Paquete x 4 tiras
Peso aprox. paq.: 25,3 kg



VENTANA CORREDIZA

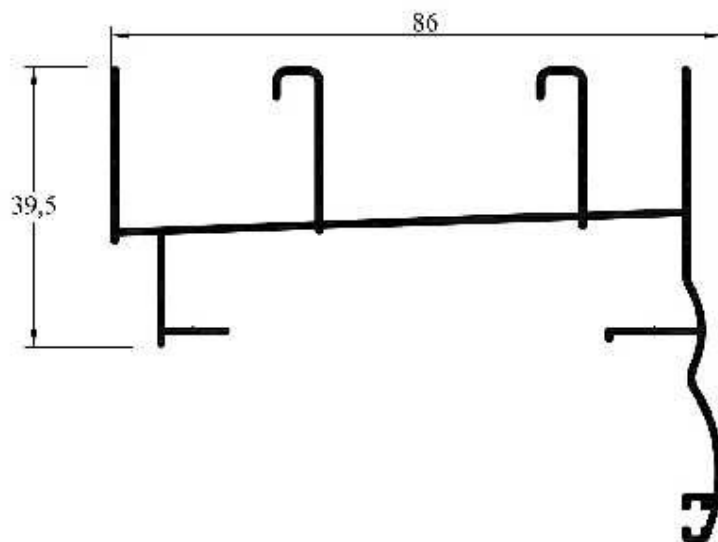

LH-067 (MPB 4251)
Marco corrediza con
contramarco
Peso: 0,740 kg/ml

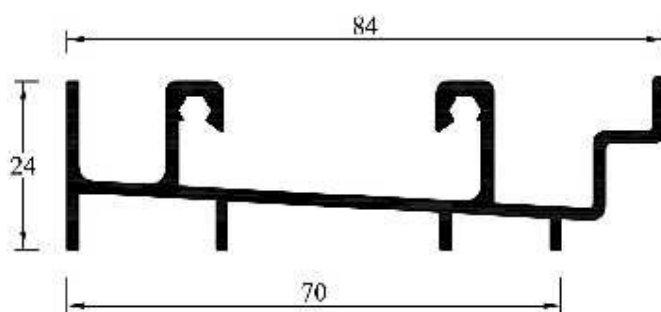

LH-017 (MPB 3645)
Umbral bajo (Balconero)
Peso: 1,050 kg/ml
Paquete x 4 tiras
Peso aprox. paq.: 25 kg

LH-045 (MPB 3602)
Marco Postizo para
Ventana Corrediza
Peso: 0,420 kg/ml
Paquete x 8 tiras
Peso aprox. paq.: 20,2 kg

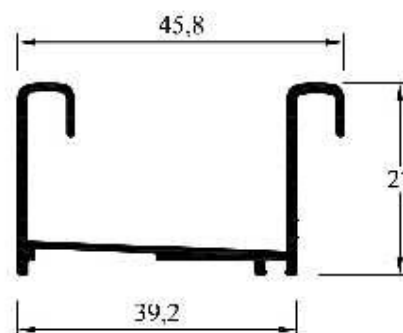

VENTANA CORREDIZA

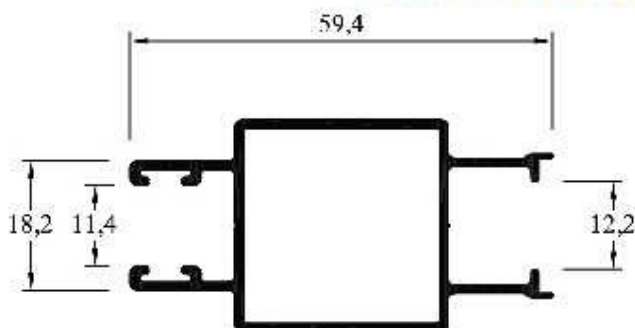

LH-153 (MPB 3938)
Parante Lateral Reforzado
 Peso: 0,621 kg/ml
 Paquete x 6 tiras
 Peso aprox. paq.: 22,4 Kg

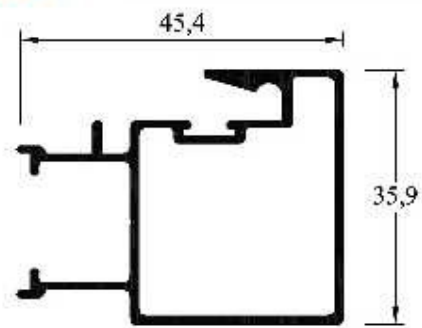

LH-154 (MPB 3939)
Parante Central Reforzado
 Peso: 0,570 kg/ml
 Paquete x 6 tiras
 Peso aprox. paq.: 20,6 kg

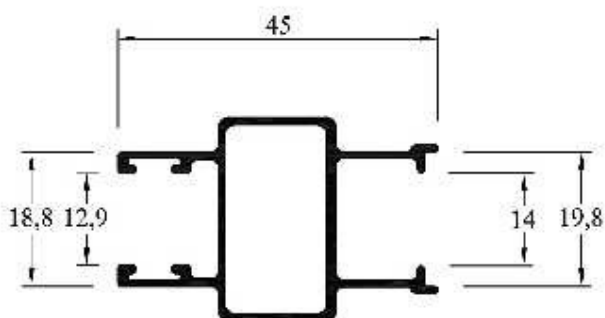

LH-003 (MPB 3546)
Parante Lateral Grande
 Peso: 0,425kg/ml
 Paquete x 8 tiras
 Peso aprox. paq.: 20,5 kg

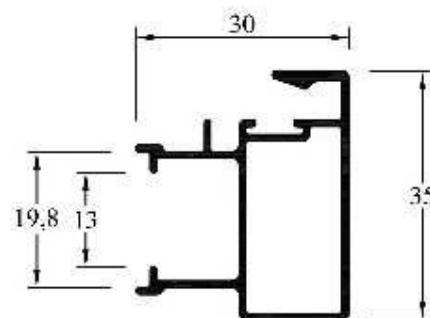

LH-004 (MPB 3549)
Parante Central Grande
 Peso: 0,425 kg/ml
 Paquete x 8 tiras
 Peso aprox. paq.: 20,5 kg

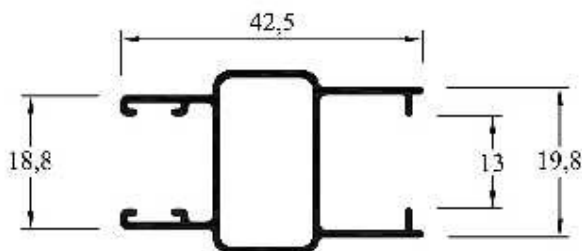

LH-103 (MPB 4103)
Parante Lateral Chico
 Pcs: 0,365 kg/ml
 Paquete x 8 tiras
 Peso aprox. paq.: 17,7 kg

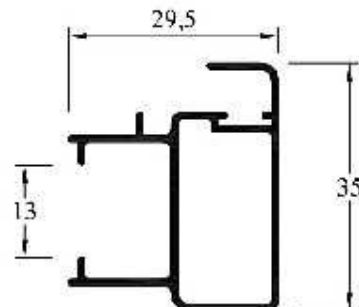

LH-104 (MPB 4104)
Parante Central Chico
 Peso: 0,350 kg/ml
 Paquete x 8 tiras
 Peso aprox. paq.: 16,9 kg

VENTANA CORREDIZA

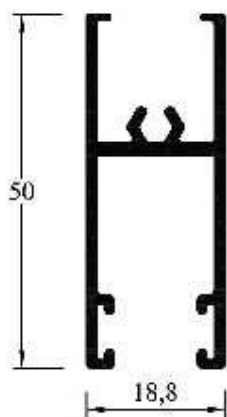

LH-002 (MPB 3774)
Cabezal/ Zócalo Hoja
 Peso: 0,400 kg/ml
 Paquete x 8 tiras
 Peso aprox. paq.: 19,2 kg

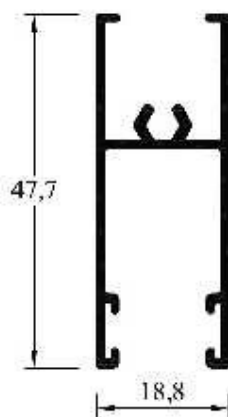

LH-102 (MPB 3826)
Cabezal/Zócalo Hoja Liviano
 Peso: 0,360 kg/ml
 Paquete x 8 tiras
 Peso aprox. paq.: 17,3 kg

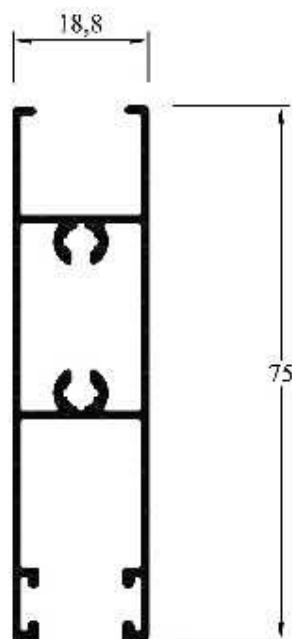

LII-044 (MPB 3929)
Zócalo Alto Hoja
 Peso: 0,670 kg/ml
 Paquete x 6 tiras
 Peso aprox. paq.: 24,2 kg

VIDRIO REPARTIDO RAYADO

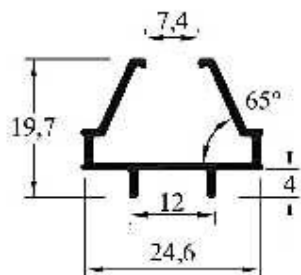

LH-018 (MPB 3761)
Perimetral VRP Rayado
 Peso: 0,195 kg/ml
 Paquete x 15 tiras
 Peso aprox. paq.: 17,6 kg

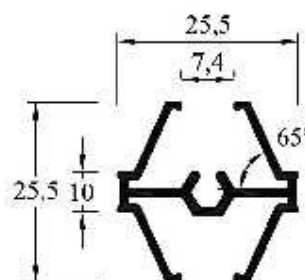

LH-019 (MPB 3550)
Nudo VRC(con Cava)
 Peso: 0,285 kg/ml
 Paquete x 10 tiras
 Peso aprox. paq.: 17,2 kg

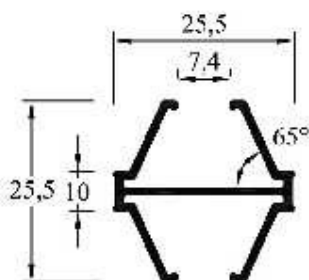

LH-020 (MPB 3762)
Nudo VRC(sin Cava)
 Peso: 0,250 kg/ml
 Paquete x 10 tiras
 Peso aprox. paq.: 15,1 kg

VIDRIO REPARTIDO LISO

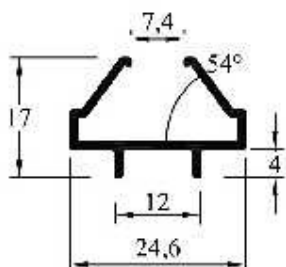

LH-022 (MPB 3394)
Perimetral VRP Liso Chico
 Peso: 0,175 kg/ml
 Paquete x 15 tiras
 Peso aprox. paq.: 15,8 kg

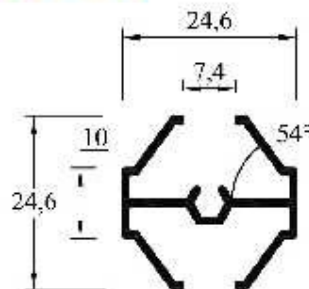

LH-023 (MPB 3943)
Nudo VRC Liso Chico (con Cava)
 Peso: 0,260 kg/ml
 Paquete x 10 tiras
 Peso aprox. paq.: 15,8 kg

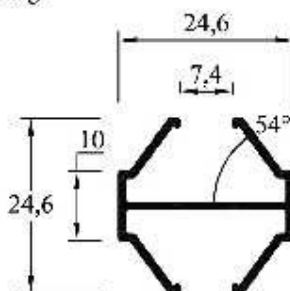

LH-024 (MPB 3397)
Nudo VRC Liso Chico (sin Cava)
 Peso: 0,245 kg/ml
 Paquete x 10 tiras
 Peso aprox. paq.: 14,8 kg

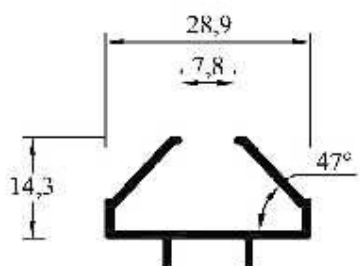

LH-025 (MPB 3502)
Marcos VRP Liso Gde
 Peso: 0,215 kg/ml
 Paquete x 15 Tiras
 Peso aprox. paq.: 19,4 kg

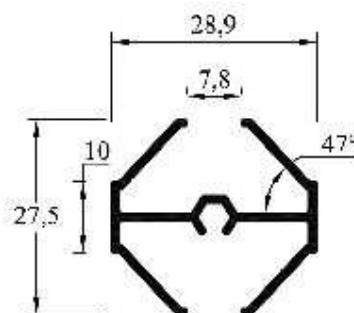

LII-026 (MPB 3503)
Nudo VRC Gde (con Cava)
 Peso: 0,330 kg/ml
 Paquete x 10 tiras
 Peso aprox. paq.: 19,8 kg

MOSQUITERO

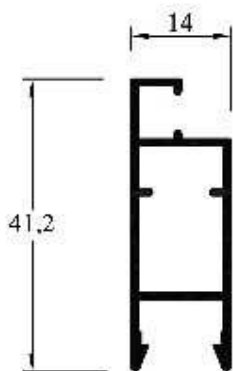

LH-005 (MPB 3708)
Hoja Mosquitero
 Peso: 0,320 kg/ml
 Paquete x 10 tiras
 Peso aprox.paq.: 19,2 kg

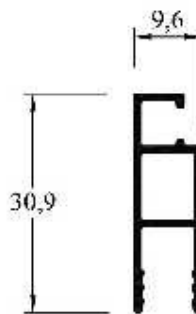

LH-006 (MPB 3406)
Mosquitero Medianito
 Peso: 0,230 kg/ml
 Paquete x 10 tiras
 Peso aprox.paq.: 13,8 kg

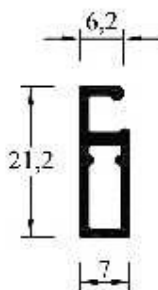

LH-009 (MPB 3650)
Canal 9
Mosquitero Liviano
 Peso: 0,190 kg/ml
 Paquete x 20 tiras
 Peso aprox.paq.: 22,8 kg

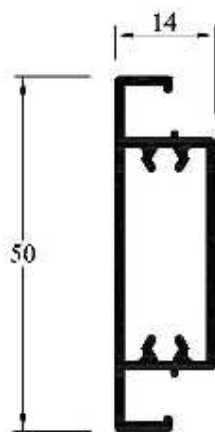

LH-090 (MPB 3647)
Travesaño Hoja Mosquitero
 Peso: 0,460 kg/ml
 Paquetes x 8 tiras
 Peso aprox. paq.: 22,1 kg

TAPACINTAS - GUIAS DE CORTINA

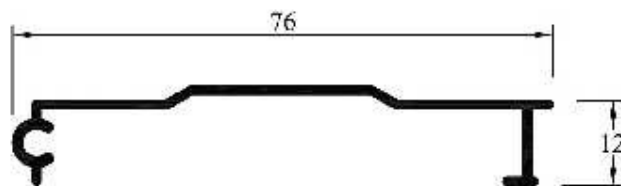

LH-014 (MPB 3701)
Tapacintas Liviano
 Peso: 0,240 kg/ml
 Paquete x 10 tiras
 Peso aprox. paq.: 14,4 kg

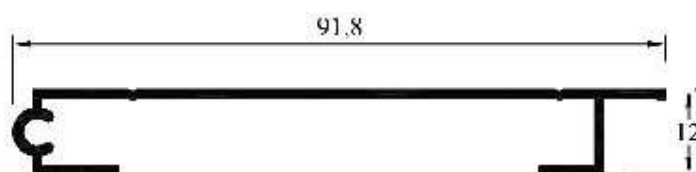

LH-015
Tapacintas Pesado
 Peso: 0,480 kg/ml
 Paquete x 8 tiras
 Peso aprox. paq.: 23,1 kg

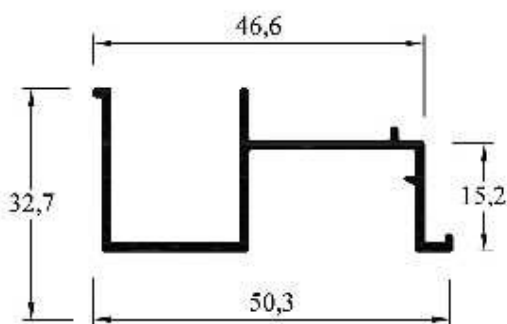

LH-011 (MPB 3551)
Guía Cortina Común
 Peso: 0,290 kg/ml
 Paquete x 10 tiras
 Peso aprox. paq.: 17,4 kg

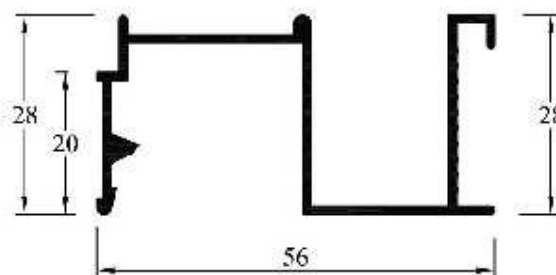

LH-012 (MPB 4238)
Guía Pesada
 Peso: 0,330 kg/ml
 Paquete x 10 tiras
 Peso aprox paq.: 19,8 kg

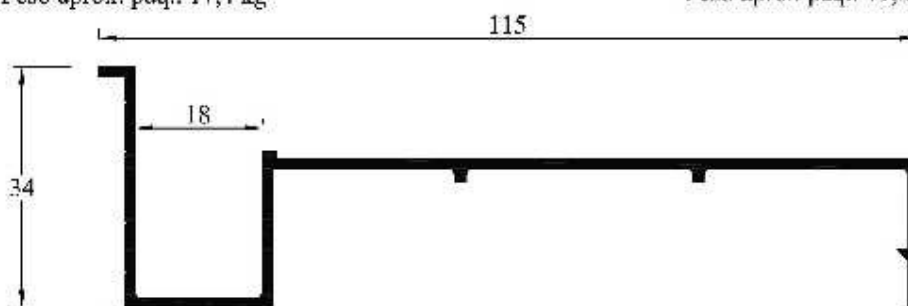

LH-021 (MPB 3893)
Guía Cortina tipo Barrios
 Peso: 0,600 kg/ml
 Paquete x 4 tiras
 Peso aprox. paq.: 14,4 kg

PAÑO FIJO

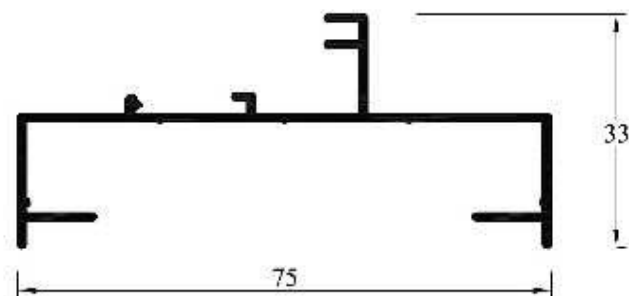

LH-007 (MPB 4252)
Marco Paño Fijo Pesado
 Peso: 0,580 kg/ml
 Paquete x 6 tiras
 Peso aprox. paq.: 20,9 kg

LH-107 (MPB 3748)
Marco Paño Fijo
 Peso: 0,450 kg/ml
 Paquete x 6 tiras
 Peso aprox paq.: 16,2 kg

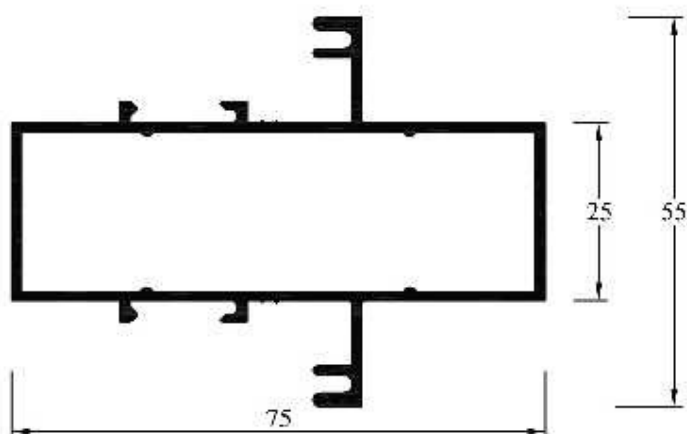

LH-094 (MPB 3649)
Travesaño Paño Fijo
 Peso: 1,180 kg/ml
 Paquete x 4 tiras
 Peso aprox. paq.: 21,3 kg

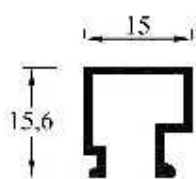

LH-010
Contravidrio para Masilla
 Peso: 0,190 kg/ml
 Paquete x 20 tiras
 Peso aprox. paq.: 22,8 kg

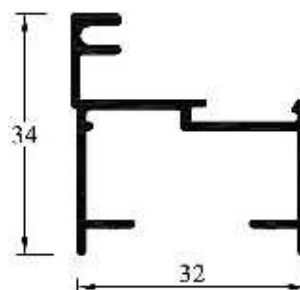

LH-074 (MPB 4160)
Marco paño fijo 32mm.
 Peso: 0,370 kg/ml
 Paquete x 6 tiras
 Peso aprox. paq.: 13,4 kg

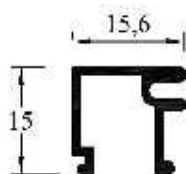

LH-008 (MPB 3662)
Contravidrio Recto
 Peso: 0,160 kg/ml
 Paquete x 20 tiras
 Peso aprox. paq.: 19,2 kg

PUERTA DE REBATIR

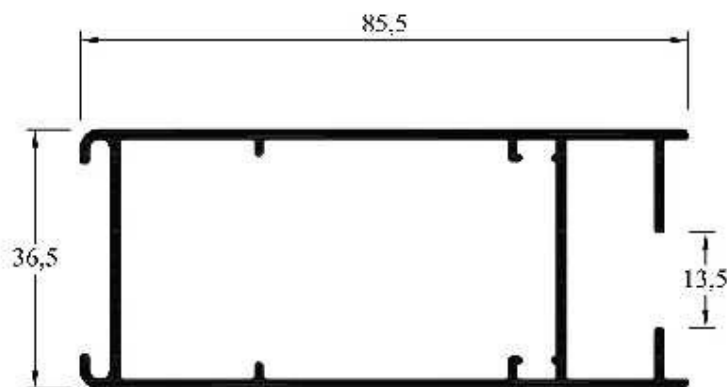

LH-041 (MPB 3891)
Parante Puerta
 Peso: 0,950 kg/ml
 Paquete x 3 tiras
 Peso aprox. paq.: 17,2 kg

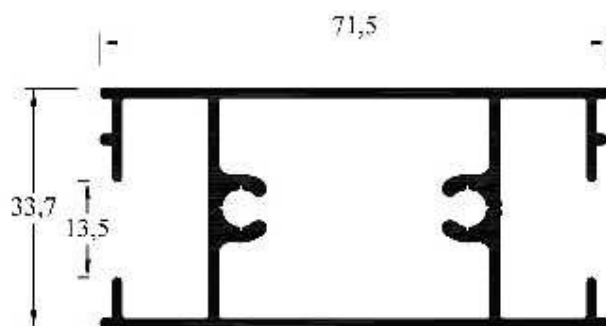

LH-042 (MPB 3892)
Cabezal/Travesaño /Zócalo de Hoja de Puerta
 Peso: 0,950 kg/ml
 Paquete x 3 tiras
 Peso aprox. paq.: 17,1 kg

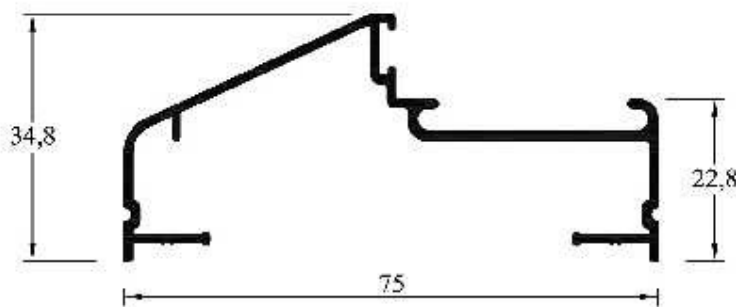

LH-043 (MPB 3555)
Marco de Puerta de Rebatir
 Peso: 0,580 kg/ml
 Paquete x 6 tiras
 Peso aprox. paq.: 20,9 kg

LH-075 (MPB 4250)
Marco de Puerta de Rebatir Pesado.
 Peso: 0,712 kg/ml
 Paquete x 6 tiras
 Peso aprox. paq.: 25,7 kg

PUERTA PLACA

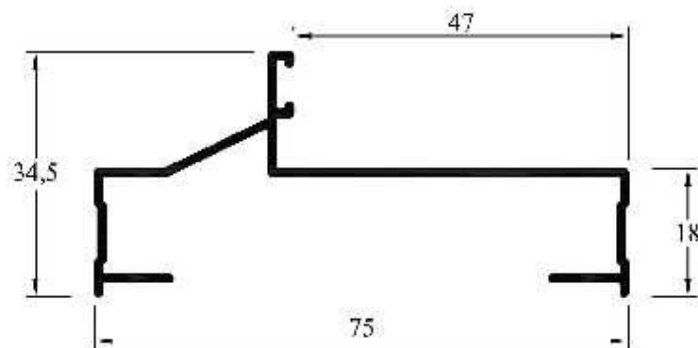

LH-058 (MPB 4027)
 Marco de Puerta Placa de 75 mm
 Peso: 0,490 kg/ml
 Paquete x 6 tiras
 Peso aprox. paq.: 17,8 kg

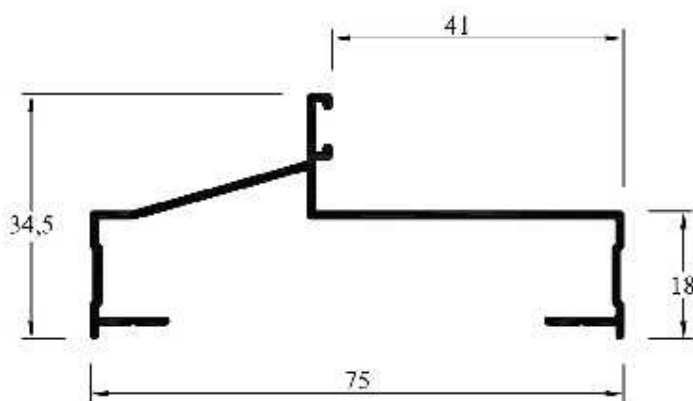

LH-109 (MPB 4048)
 Marco de Puerta Placa de 75 mm
 y 41mm de placa
 Peso: 0,465 kg/ml
 Paquete x 6 tiras
 Peso aprox. paq.: 16,9 kg

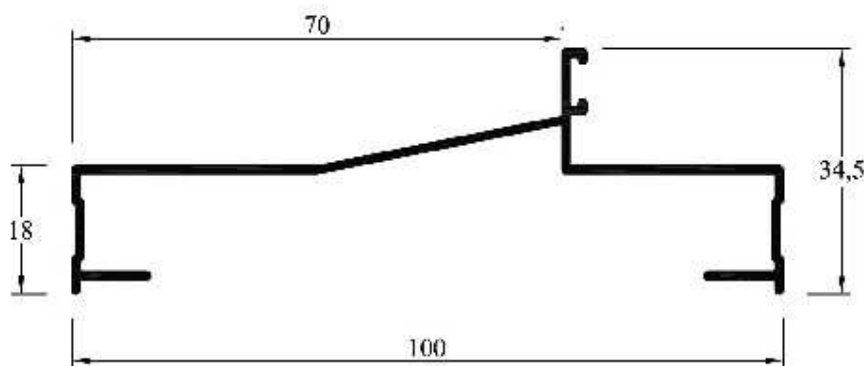

LH-059 (MPB 4078)
 Marco de Puerta
 Placa de 100 mm
 Peso: 0,510 kg/ml
 Paquete x 6 tiras
 Peso aprox. paq.: 18,5 kg

POSTIGON DE REBATIR

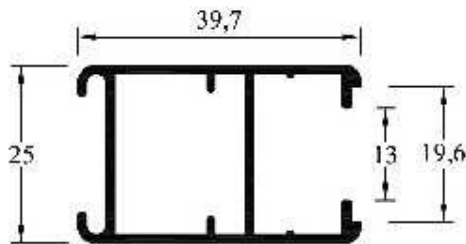

LH-028 (MPB 3785)
Parante Chico Postigón
 Peso: 0,480 kg/ml
 Paquete x 8 tiras
 Peso aprox. paq.: 23,1 kg

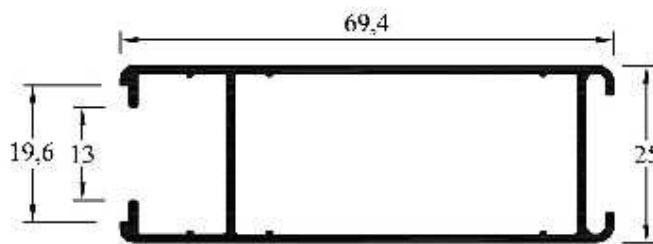

LH-029 (MPB 3823)
Parante Grande Postigón
 Peso: 0,590 kg/ml
 Paquete x 4 tiras
 Peso aprox. paq.: 13,7 kg

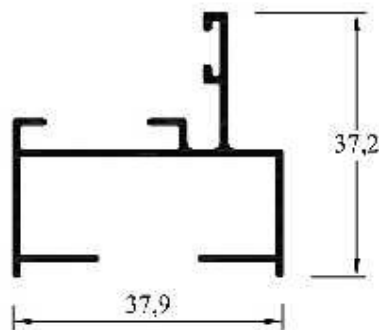

LH-030 (MPB 3900)
Marco Chico Postigón
 Peso: 0,340 kg/ml
 Paquete x 10 tiras
 Peso aprox. paq.: 20,4 kg

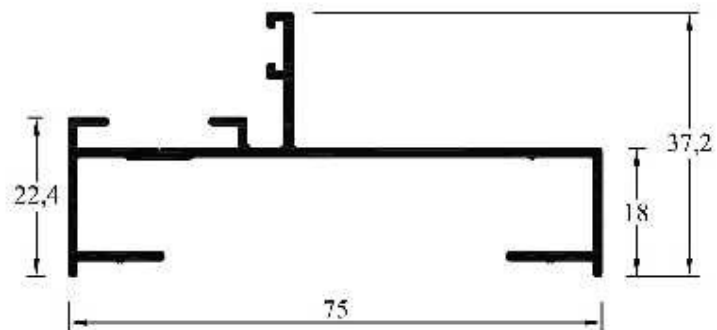

LH-031 (MPB 3789)
Marco Postigón Grande
 Peso: 0,560 kg/ml
 Paquete x 6 tiras
 Peso aprox. paq.: 20,2 kg

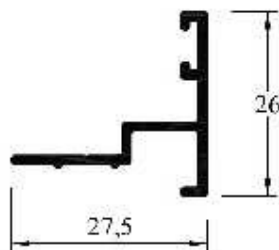

LH-073 (MPB 4219)
Encuentro Hoja
 Peso: 0,230 kg/ml

REBATIR CON VIDRIO REPARTIDO

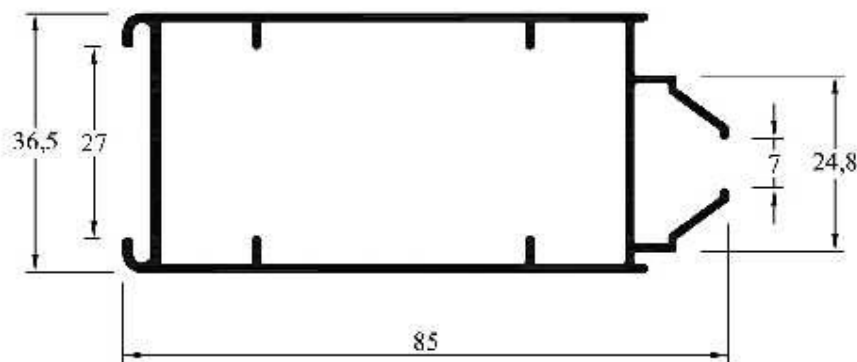

LH-062 (MPB 4133)
Parante de Puerta con Vidrio Repartido
 Peso: 0,805 kg/ml
 Paquete x 3 tiras
 Peso aprox. paq.: 14,6 kg

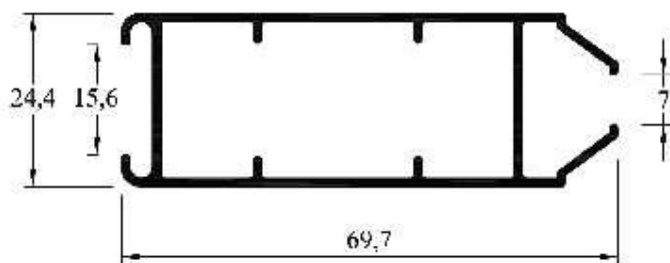

LH-063 (MPB 4134)
Parante Grande Postigón con Vidrio Repartido
 Peso: 0,640 kg/ml
 Paquete x 4 tiras
 Peso aprox. paq.: 15,5 kg

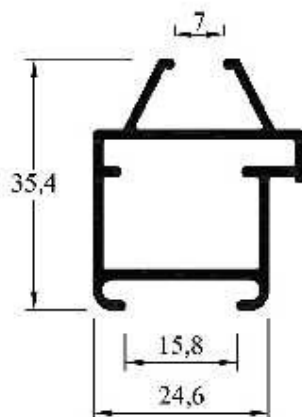

LH-064 (MPB 4138)
Parante Chico Postigón con Vidrio Repartido
 Peso: 0,465 kg/ml
 Paquete x 8 tiras
 Peso aprox. paq.: 22,4 kg

TABLILLA DE POSTIGÓN

LH-032 (MPB 3335)
Tablilla Postigón Recta
 Peso: 0,260 kg/ml
 Paquete x 10 tiras
 peso aprox. paq.: 15,6

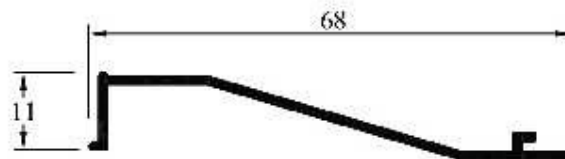

LH-033 (MPB 3328)
Tablilla Celosía Veneciana
 Peso: 0,160 kg/ml
 Paquete x 15 tiras
 Peso aprox. paq.: 14,4 kg

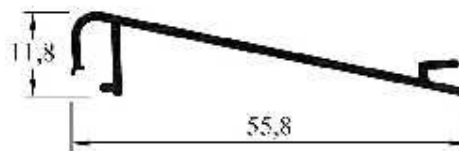

LH-060 (MPB 4052)
Tablilla Curva
 Peso: 0,275 kg/ml
 Paquete x 10 tiras
 peso aprox. paq.: 18 Kg



REVESTIMIENTO

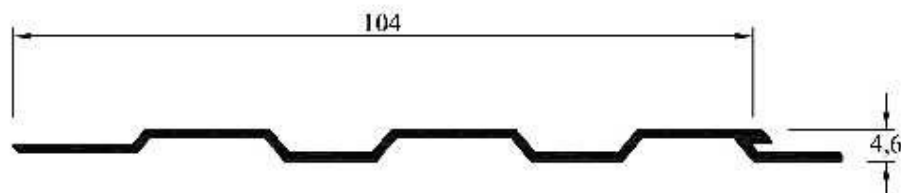

LH-046 (MPB 3630)
Revestimiento Liviano (ACAN 5mm)
 Peso: 0,490 kg/ml
 Paquete x 5 tiras
 Peso aprox. paq.: 14,7 kg

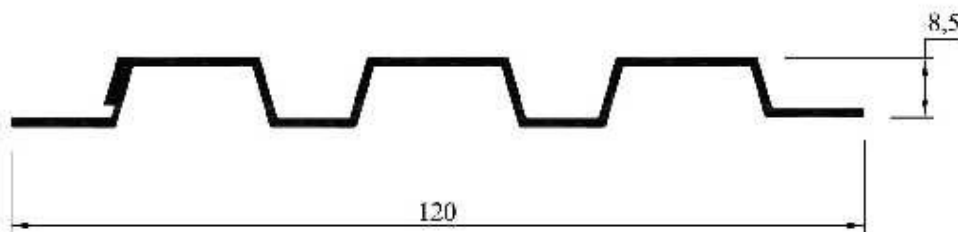

LH-047 (MPB 3646)
Revestimiento (ACAN 9mm)
 Peso: 0,550 kg/ml
 Paquete x 5 tiras
 Peso aprox. paq.: 16,5 kg

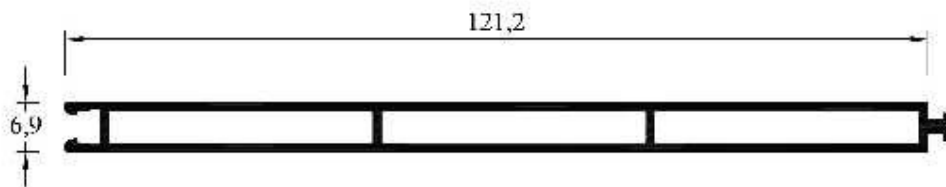

LH-048 (MPB 3757)
Revestimiento Tubular
 Peso: 0,800 kg/ml
 Paquete x 5 tiras
 Peso aprox. paq.: 24,2 kg

TUBOS LISOS

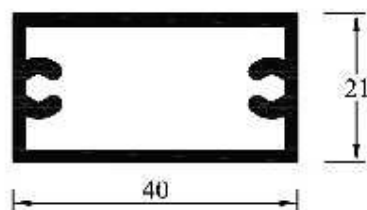

LH-076 (MPB 4161)
Tubo 40 x 21 mm c/Cavas
 Peso: 0,670 kg/ml
 Paquete x 4 tiras
 Peso aprox. paq.: 16,2 kg

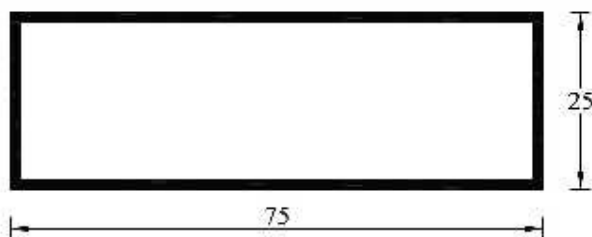

LH-036
Tubo 75 x 25 mm Liso
 Peso: 0,870 kg/ml
 Paquete x 4 tiras
 Peso aprox. paq.: 20,9 kg

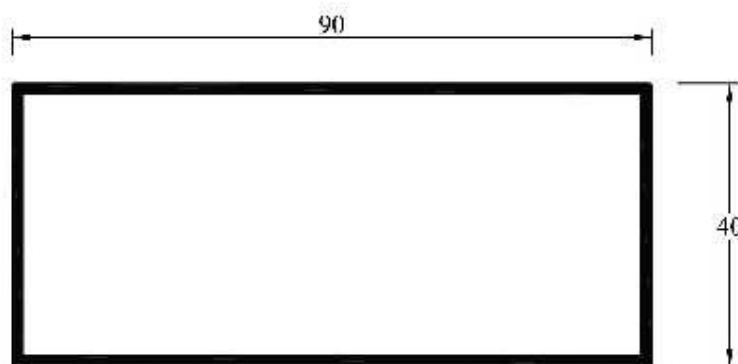

LH-037
Tubo 90 x 40 mm Liso
 Peso: 1,340 kg/ml
 Paquete x 3 tiras
 Peso aprox. paq.: 24,2 kg

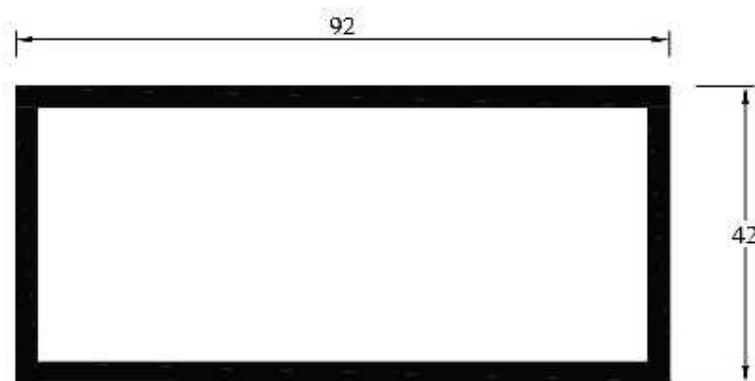

LH-038
Tubo 90 x 42 x 3mm Liso
 Peso: 2,081 kg/ml

TABIQUES

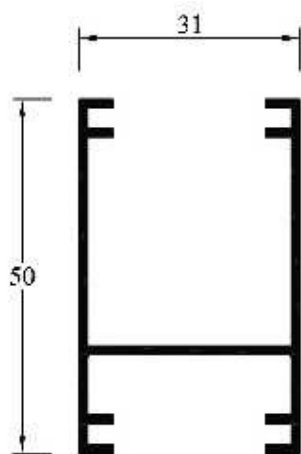

LH-049 (MPB 3526)
Travesaño Tabique
 Peso: 0,560 kg/ml
 Paquete x 6 tiras
 Peso aprox. paq.: 20,2 kg

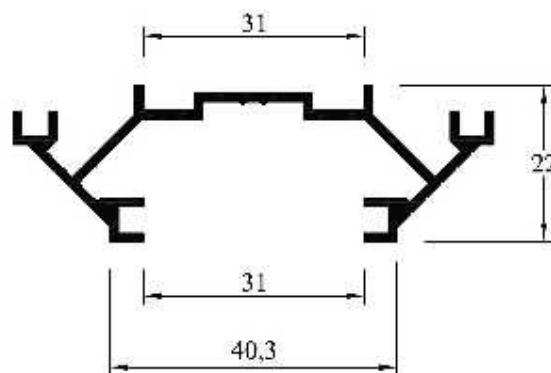

LH-050 (MPB 3725)
Tapa Columna Tabique
 Peso: 0,600 kg/ml
 Paquete x 4 tiras
 Peso aprox. paq.: 14,4 kg

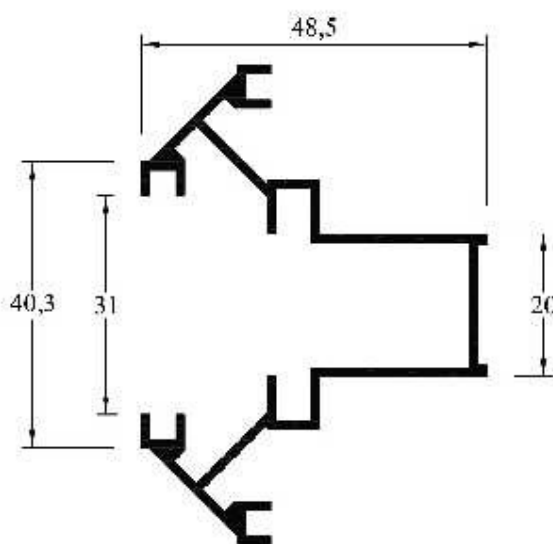

LH-051 (MPB 3527)
Columna Tabique
 Peso: 0,710 kg/ml
 Paquete x 4 tiras
 Peso aprox. paq.: 17,1 kg

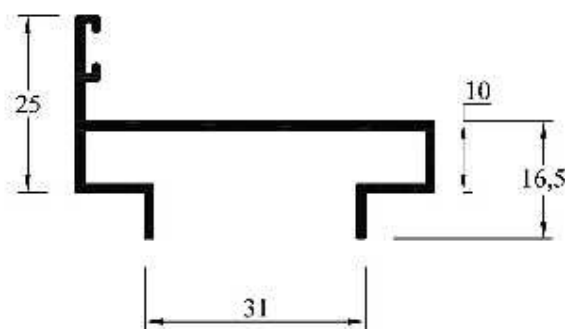

LH-052 (MPB 3811)
Marco Puerta Placa
 Peso: 0,400 kg/ml
 Paquete x 4 tiras
 Peso aprox. paq.: 9,6 kg

AIREADORES

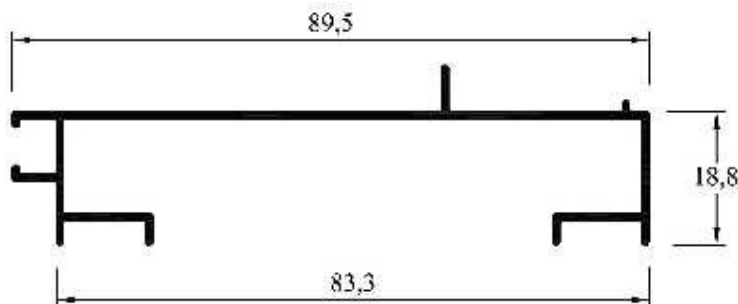

LII-053 (MPB 3824)
Marco Aireador c/ Aleta y Mosquitero
 Peso: 0,450 kg/ml
 Paquete x 6 tiras
 Peso aprox. paq.: 16,2 kg



LH-055 (MPB 3574)
Unionero
 Peso: 0,530 kg/ml
 Paquete x 6 tiras
 Peso aprox. paq.: 19,1 kg

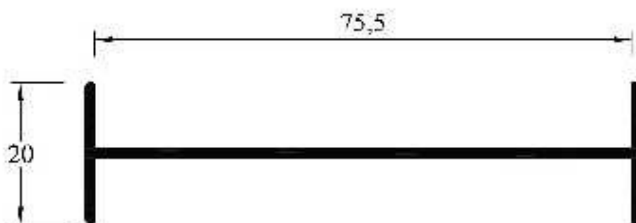

LH-066 (MPB 4175)
Unionero pata larga liviano
 Peso: 0,375 kg/ml
 Paquete x 6 tiras
 Peso aprox. paq.: 13,6 kg

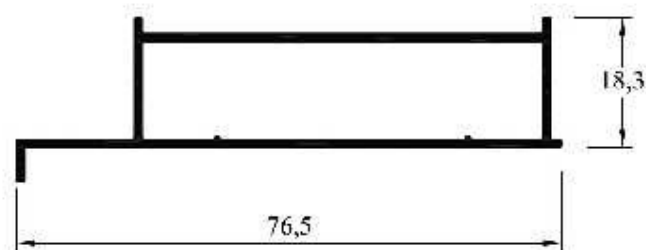

LH-054 (MPB 4024)
Premarco
 Peso: 0,560 kg/ml
 Paquete x 4 tiras
 Peso aprox. paq.: 13,6 kg



ESCUADRAS

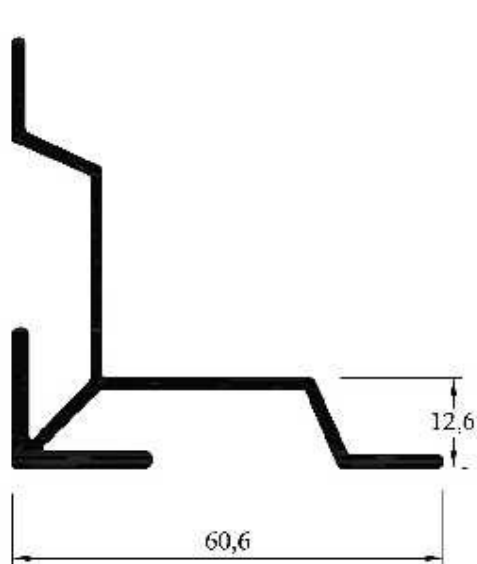

LH-016 (MPB 3749)
Escuadra 13 mm Pesada
 Peso: 0,520kg/ml
 Paquete x 4 tiras
 Peso aprox. paq.: 12,5 kg

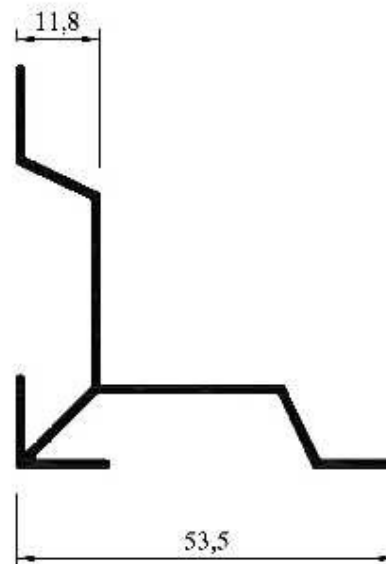

LH-027 (MPB 3752)
Escuadra 2001 Liviana
 Peso: 0,350 kg/ml
 Paquete x 6 tiras
 Peso aprox. paq.: 12,6 kg

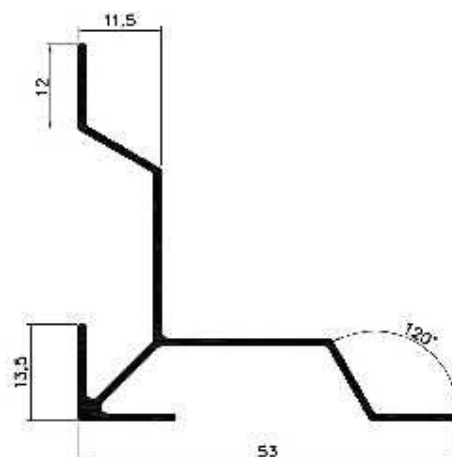

LH-159 (MPB 4348)
Escuadra reforzada
 Peso: 0,480 kg/ml
 Paquete x 6 tiras
 Peso aprox. paq.: 17,3 kg

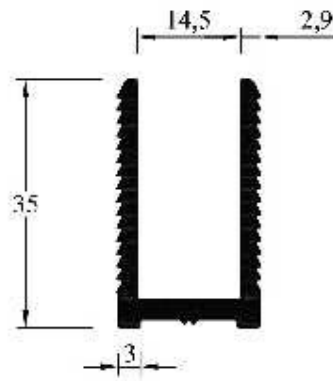

LH-034 (MPB 3775)
U de armado 75x25 Parte ABA
Peso: 0,575 kg/ml
Paquete x 6 tiras
Peso aprox. paq.: 20,8 kg

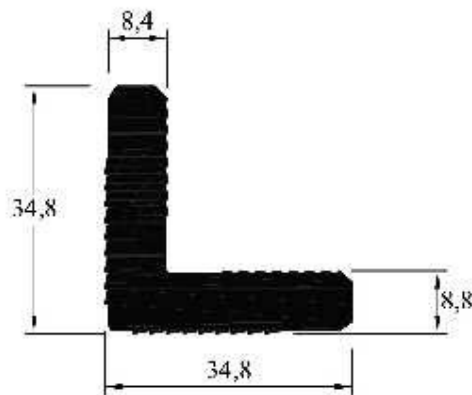

LH-035 (MPB 3805)
Escuadra Estriada
Peso: 1,230 kg/ml
Paquete x 3 tiras
Peso aprox. paq.: 22,2 kg

VENTANA BANDEROLA

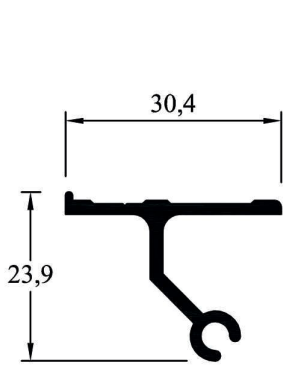

LH-068 (MPB 4240)
Bisagra Banderola
Peso: 0,275kg/ml

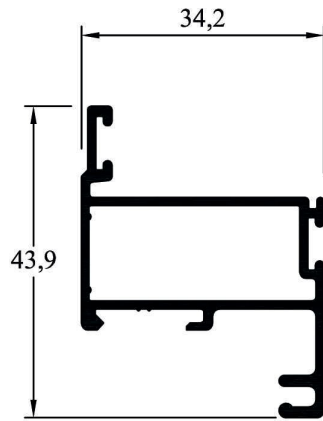

LH-071 (MPB 4243)
Hoja Inferior
Peso: 0,495kg/ml

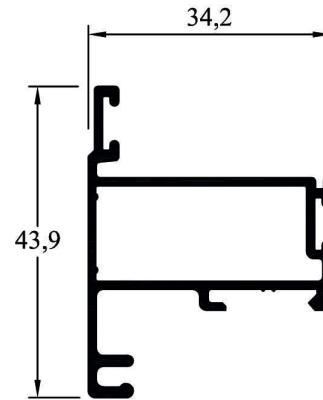

LH-072 (MPB 4244)
Hoja Superior
Peso: 0,495kg/ml

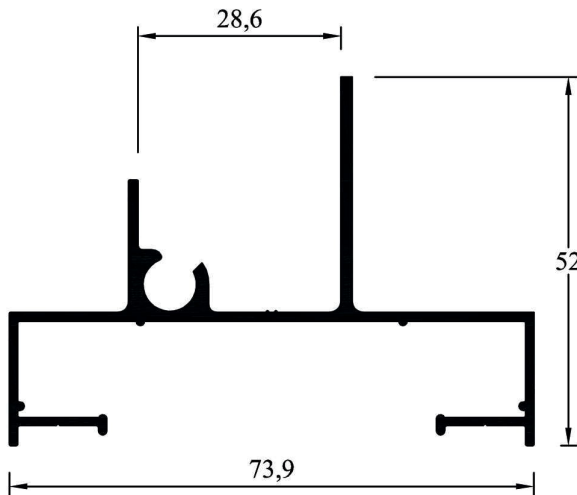

LH-069 (MPB 4241)
Marco Ventana Banderola
Peso: 0,735 kg/ml

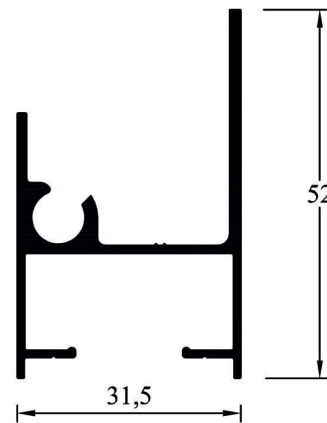

LH-070 (MPB 4242)
Marco Chico Ventana Banderola
Peso: 0,525 kg/ml

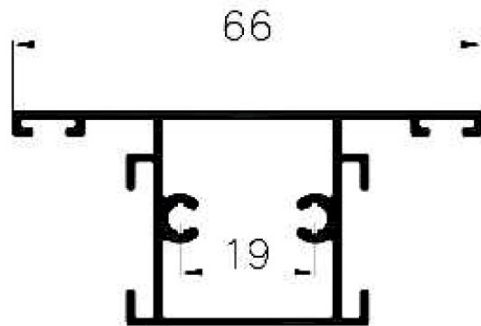

LH-155 (MPB 4342)
Travesaño
Peso: 0,640 kg/ml

LH-156 (MPB 4343)
Contravidrio universal
Peso: 0,205 kg/ml

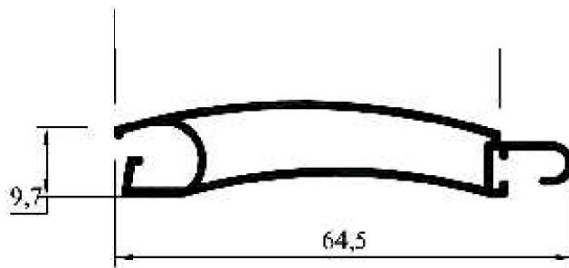
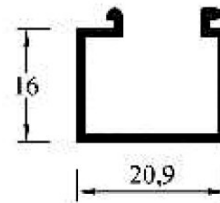

LH-307 (MPB 4249)
Tablilla cortina de
enrollar
Peso: 0,420 kg/ml

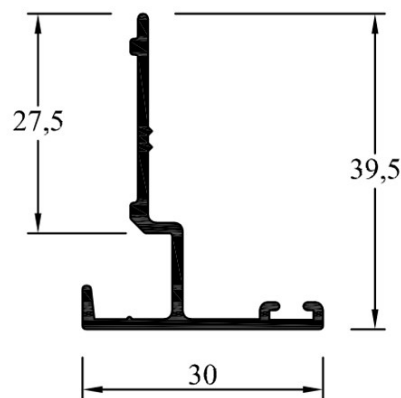

LH-945 (MPB 4481)
Encuentro de hoja 36 mm
Peso: 0,297 kg/ml
Paquete x 10 tiras
Peso aprox. paq.: 18 kg